

LUNA

12251



 = motorized headrest

Effective: 10/11/2018

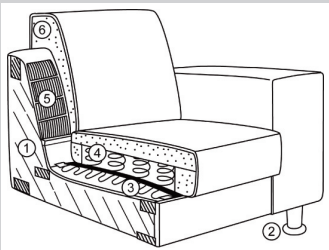

- 1. Frame:**
Consists of hardwood and top-grade 3/4" plywood
- 2. Legs:**
Standard wooden leg - F130 (available in all wood finishes)
- 3. Lower suspension:**
No-sag springs
- 4. Seat:**
Coil springs encased in high density polyurethane foam and dacron
- 5. Back suspension:**
Elastic webbing
- 6. Back:**
Mixture of shredded foam with dacron

F130



Cupholder color options:
*Standard silver cupholder
**Optional black cupholder

Additional information:
Contrast stitching available.
Please refer to samples.
Two-tone combinations not available.

Sectional pieces without incliner:

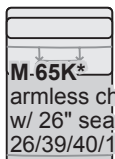

M-65K*
armless chair
w/ 26" seat
26/39/40/19*

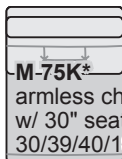

M-75K*
armless chair
w/ 30" seat
30/39/40/19*

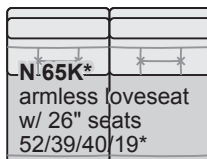

N-65K*
armless loveseat
w/ 26" seats
52/39/40/19*

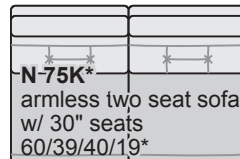

N-75K*
armless two seat sofa
w/ 30" seats
60/39/40/19*

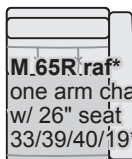

M-65R.raf*
one arm chair
w/ 26" seat
33/39/40/19*

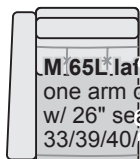

M-65L.laf*
one arm chair
w/ 26" seat
33/39/40/19*

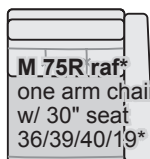

M-75R.raf*
one arm chair
w/ 30" seat
36/39/40/19*



M-75L.laf*
one arm chair
w/ 30" seat
36/39/40/19*

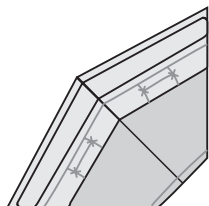

ET*
corner
50/50/39/19*

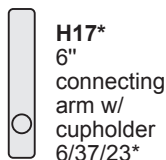

H17*
6"
connecting
arm w/
cupholder
6/37/23*

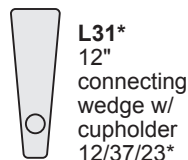

L31*
12"
connecting
wedge w/
cupholder
12/37/23*

Freestanding pieces without incliner:



G 75*
ottoman
30/30/19*

All measurements are approximate: width/depth/height/seat height.
Seat depth 22", arm height 23", arm width 7".
Line drawings are in 1/4" scale.

See next page.

LUNA

12251



= motorized headrest

Effective: 10/11/2018

Sectional pieces with incliner and power headrest:

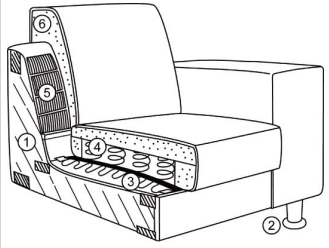

- 1. Frame:**
Consists of hardwood and top-grade 3/4" plywood
- 2. Legs:**
Standard wooden leg - F130 (available in all wood finishes)
- 3. Lower suspension:**
No-sag springs
- 4. Seat:**
Coil springs encased in high density polyurethane foam and dacron
- 5. Back suspension:**
Elastic webbing
- 6. Back:**
Mixture of shredded foam with dacron

F130



Cupholder color options:

- *Standard silver cupholder
- **Optional black cupholder

Additional information:

- Contrast stitching available. Please refer to samples.
- Two-tone combinations not available.

<p>MM 65K* armless chair w/ 26" seat & incliner 26/39/40/19*</p>	<p>MM 75K* armless chair w/ 30" seat & incliner 30/39/40/19*</p>	<p>NM 65K* armless loveseat w/ 26" seats & incliners 52/39/40/19*</p>	<p>NM 75K* armless two seat sofa w/ 30" seats & incliners 60/39/40/19*</p>
<p>MM 65R raf* one-arm chair w/ 26" seat & incliner 33/39/40/19*</p>	<p>MM 65L raf* one-arm chair w/ 26" seat & incliner 33/39/40/19*</p>	<p>MM 75R raf* one-arm chair w/ 30" seat & incliner 36/39/40/19*</p>	<p>MM 75L raf* one-arm chair w/ 30" seat & incliner 36/39/40/19*</p>
<p>NM 65R raf* one-arm loveseat w/ 26" seats & incliner RAF 59/39/40/19*</p>	<p>NM 65L raf* one-arm loveseat w/ 26" seats & incliner LAF 59/39/40/19*</p>	<p>NM 75R raf* one-arm two seat sofa w/ 30" seats & incliner RAF 69/40/40/19*</p>	
<p>NM 75L raf* one-arm two seat sofa w/ 30" seats & incliner LAF 69/40/40/19*</p>	<p>KM 65R raf* one arm chaise w/ 26" seat 33/66/40/19*</p>	<p>KM 65L raf* one arm chaise w/ 26" seat 33/66/40/19*</p>	<p>**Total depth of KM65R/L fully inclined: 78**</p>

****All skus with "MM", "NM" and "PM" include power.**

****A manual incliner is not available.**

Total depth fully inclined: 61"

All measurements are approximate: width/depth/height/seat height.
Seat depth 22", arm height 23", arm width 7".
Line drawings are in 1/4" scale.

<p>Rechargeable battery pack BU36 - RAF BU30 - middle BU37 - LAF</p>	<p>Additional power seat IMR - right seat IMM - middle seat IML - left seat</p>
---	--

See next page.



W.SCHILLIG

LUNA

12251



 = motorized headrest

Effective: 10/11/2018

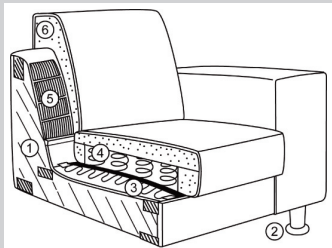

- 1. Frame:**
Consists of hardwood and top-grade 3/4" plywood
- 2. Legs:**
Standard wooden leg - F130 (available in all wood finishes)
- 3. Lower suspension:**
No-sag springs
- 4. Seat:**
Coil springs encased in high density polyurethane foam and dacron
- 5. Back suspension:**
Elastic webbing
- 6. Back:**
Mixture of shredded foam with dacron

F130



Cupholder color options:
*Standard silver cupholder
**Optional black cupholder

Additional information:
Contrast stitching available.
Please refer to samples.
Two-tone combinations not available.

Sectional pieces with incliner and power headrest:

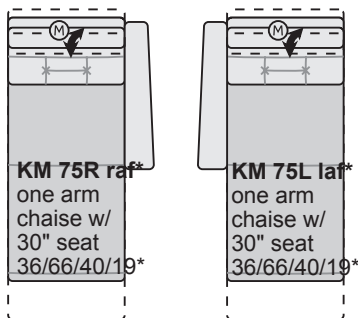

Total depth of KM75R/L fully inclined: 78

Freestanding pieces with incliner and power headrest:

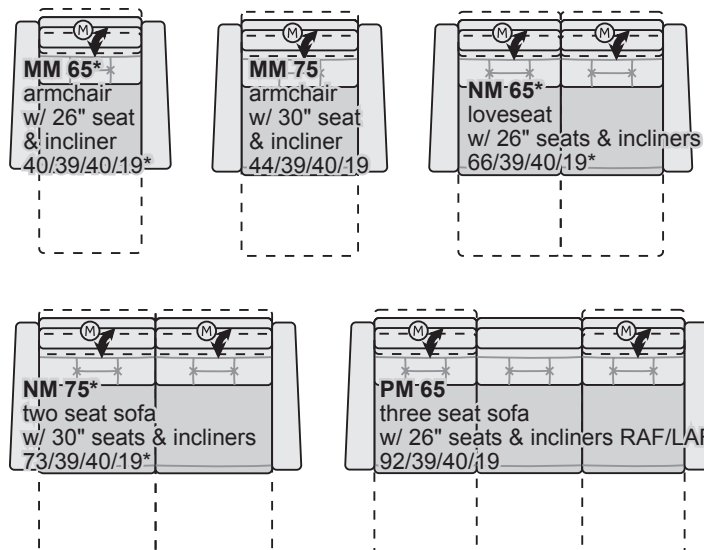

****All skus with "MM", "NM" and "PM" include power.**

****A manual incliner is not available.**

Total depth fully inclined: 61"

All measurements are approximate: width/depth/height/seat height.
Seat depth 22", arm height 23", arm width 7".
Line drawings are in 1/4" scale.

W.SCHILLIG



Rechargeable battery pack
BU36 - RAF
BU30 - middle
BU37 - LAF



Additional power seat
IMR - right seat
IMM - middle seat
IML - left seat